



152 Robbins Rd, Downingtown, PA, 19335, USA - [HuddleCamHD.com](http://HuddleCamHD.com) | 1 800 - 486-5276

## HuddleCamHD 10x (Gen 3)

USB 3.0 PTZ CAMERA

INSTALLATION & OPERATION MANUAL





152 Robbins Rd, Downingtown, PA, 19335, USA - HuddleCamHD.com | 1 800 - 486-5276

## Precautions.....

### Safety Tips.....

- Please read this manual carefully before using the camera.
- Avoid damage from stress, violent vibration or liquid intrusion during transportation, storage or installation.
- Take care of the camera during installation to prevent damage to the camera case, ports, lens or PTZ mechanism.
- Do not apply excessive voltage. (Use only the specified voltage.) Otherwise, you may experience electrical shock.
- Keep the camera away from strong electromagnetic sources.
- Do not aim the camera at bright light sources (e.g. bright lights, the sun, etc.) for extended periods of time.
- Do not clean the camera with any active chemicals or corrosive detergents.
- Do not disassemble the camera or any of the camera's components. If problems arise, please contact your authorized dealer.
- After long term operation, moving components can wear down. Contact your authorized dealer for repair.

## In The Box.....

### Supplied Equipment

- HD Color Video Camera (1)
- 12V/2.0A DC Power Adapter (1)
- Installation Bracket (1)
- Installation Screw (1)
- USB 3.0 Data Cable (3m), Serial Control Cables (RS-232C and RS-485)
- IR Remote Controller (1)
- User Manual (1)

## Physical Description.....

### 1. Front View.....



1. **Lens**
2. **IR Receiver**  
To receive IR remote controller signal.
3. **Power LED**  
Blue LED lights when unit is powered and on.
4. **Stand by LED**  
Orange LED lights when unit is powered and in standby.
5. **IR Receiver**  
To receive IR remote controller signal.

## 2. Rear View.....

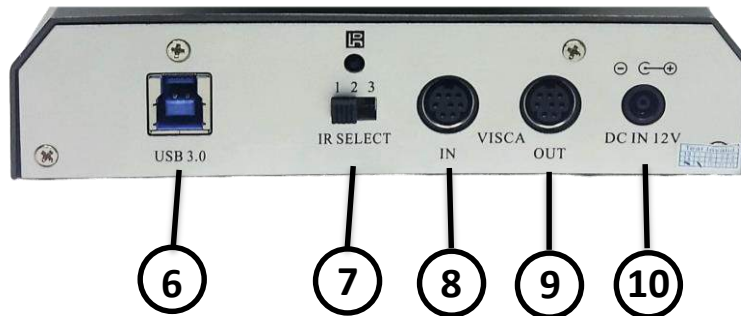

### 6. USB 3.0 Interface

For connection to PC USB 3.0 port (also compatible with USB 2.0 port and driver).

### 7. IR Selective Switch

When using only one remote to control more than one camera, this switch will assign a unique ID to each camera.

### 8. VISCA IN Port

For hard wired remote control from a 3<sup>rd</sup> party PC, joystick, etc...

### 9. VISCA Out Port/RS485

Used for daisy chaining multiple cameras for RS-232 RS-485 control.

### 10. DC IN 12V Socket

Only use the Power Adapter supplied with this camera.

## 1. Bottom View.....

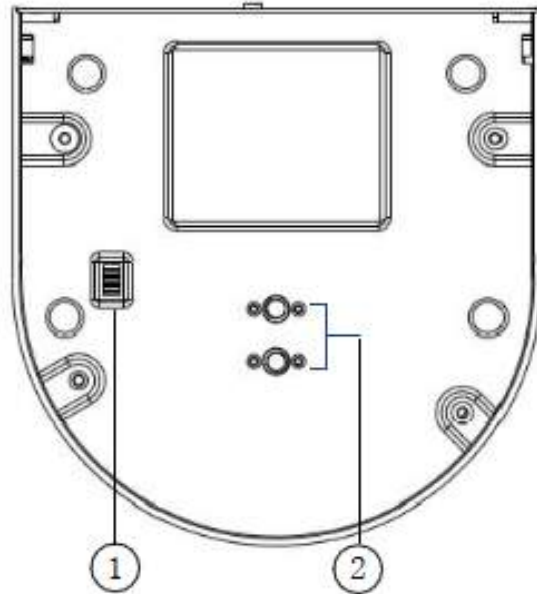

### 1. Dip-Switch

Used for selecting baud rate and the remote signal output switch.

### 2. Tripod

Will accept 1/4-20 bolt from 3<sup>rd</sup> party tripod, wall or ceiling mount.

## 4. Dip-Switch Settings.....

Note: When changing Dip-Switch settings, make all changes with camera powered off.

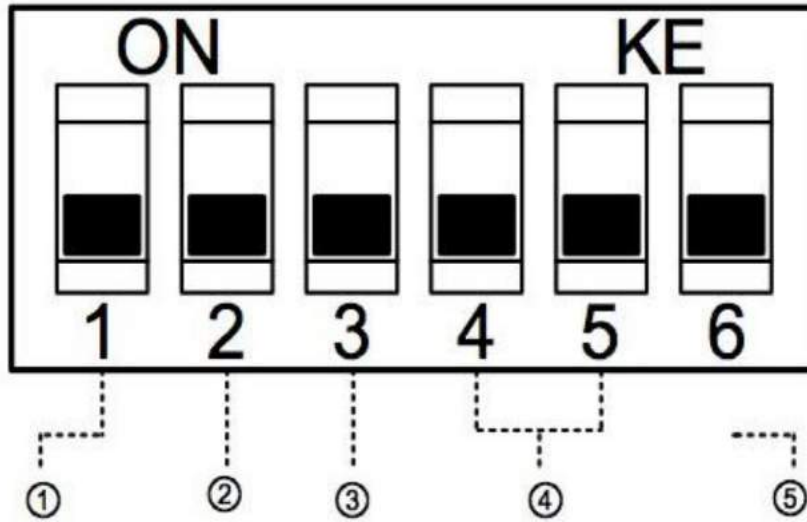

Dip-Switch 1 - (To set communication baud rate).

Dip-Switch 2 - (To set control protocol).

Dip-Switch 3 - (Set only for firmware upgrading).

Dip Switch 4 & 5 - (To set camera's RS232/RS485 ID number - for daisy chain wired control).

**Camera address code setting**

	Dip-switch4	Dip-switch 5
1	OFF	OFF
1	OFF	ON
2	ON	OFF
3	ON	ON

[Cable Connection Info.....](#)

[VISCA RS-232C - IN Reference.....](#)

VISCA RS-232C IN

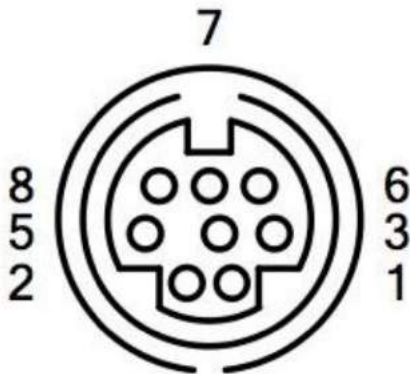

Pin S/N	Function
1	DTR IN
2	DSR IN
3	TXD IN
4	GND
5	RXD IN
6	GND
7	IR Commander Signal OUTPUT
8	NO Connection

[VISCA RS-232C - Out Reference.....](#)

VISCA RS-232C OUT

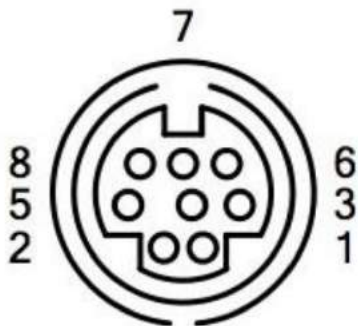

Pin S/N	Function	
	RS-232	RS-485
1	DTR OUT	TX+
2	DSR OUT	TX-
3	TXD OUT	
4	GND	
5	RXD OUT	
6	GND	
7		RS-485 -
8		RS-485 +

**Note:** RS-485 connection (in/out) is only made to the VISCA Out port



152 Robbins Rd, Downingtown, PA, 19335, USA - [HuddleCamHD.com](http://HuddleCamHD.com) | 1 800 - 486-5276

## OSD MENU.....

On Screen Display Menu - Use the OSD menu to access and change the camera's settings.

**Note:** You cannot manually move the camera (pan/tilt) when the OSD menu is visible on the screen.

### The Dome OSD Menu is as follows:

- Pan Speed Default Value: 20
  - Set speed of Pan motor
    - Range = 1 - 63
- Tilt Speed Default Value: 20
  - Set speed of Pan motor
    - Range = 1 - 63
- Scan Speed (Auto Pan Mode) Default Value: 6
  - Set speed of boundary scan
    - Range = 1 - 63
- Tour Path (uses presets) Default Value: 1
  - Select desired tour path
    - Range = 1 - 4
- Tour Dwell Default Value: 5
  - Set duration to dwell on each preset
    - Range = 1 - 60
- Proportion Default Value: On  
(Pan + Tilt speed proportional to Zoom level)
  - Set Proportion
    - Range = On - Off
- Auto Rev Default Value: P
  - Set camera mounting orientation
    - N for inv ceiling mount, P for std. mount





152 Robbins Rd, Downingtown, PA, 19335, USA - [HuddleCamHD.com](http://HuddleCamHD.com) | 1 800 - 486-5276

- **Frame** Default Value: 60Hz
  - **Set Refresh Rate**
    - Range = 50Hz or 60 Hz
- **Preset Freeze** Default Value: Off

(Provides automatic temporary freeze frame when switching between presets)

  - Range = On - Off

The Lens OSD Menu is as follows:

- **BL (Backlight)** Default Value: OFF
  - ON/OFF
- **SATURATION** Default Value: 9
  - 0-15
- **SHARPNESS** Default Value: 3
  - 0-15
- **NR (Noise Reduction)** Default Value: Auto
  - Adjustable Value: Off, AUTO, 1-4
- **WB (White Balance)** Default Value: Auto
  - Auto/Manual/Outdoor/Indoor/One Push/ATW

(Manual Settings):

- **R GAIN (Red Gain)** Default Value: 76
  - Adjustable Scope: 0-255
- **B GAIN (Blue Gain)** Default Value: 82
  - Adjustable Scope: 0-255
- **AE (Auto Exposure)** Default Value: Auto
  - Auto/Manual/Shutter/Iris/Bright

(Manual Settings):

- **SHUTTER** Default Value: 1/90
  - Shutter Speed Range: 1/60-1/10000
- **IRIS** Default Value: F8.0
  - Close, F1.6-F14



152 Robbins Rd, Downingtown, PA, 19335, USA - [HuddleCamHD.com](http://HuddleCamHD.com) | 1 800 - 486-5276

- **BRIGHT** Default Value: 23
  - Set Brightness 0 - 31

## IR Remote Controller (Note: Some buttons do not operate for all camera models)

1. **Reset:**  
Restarts the camera and restores it to Factory Default settings.  
(Note: Will delete all memory).
2. **Camera Selection**  
Select Camera ID: 1, 2 or 3
3. **Preset Positions**  
1-9: Preset Positions  
Set: Setting Preset Position  
Clear: Clear Preset Position  
Call: Call Preset Position  
**Note:** If you want to set (or call) the first preset position to 1, you should press number key "1", then press "Set" (or "Call") to set (call) the position.
4. **Fast Zoom in/out Control Zone**  
+: Zoom in quickly  
-: Zoom out quickly
5. **Pan/Tilt Controller**
  - ↑ Move Up
  - ↓ Move Down
  - ← Move Left
  - Move Right
  - ⏪ Auto Pan
6. **Additional Function Zone**  
Freeze: Image Freeze  
BL: Back-light Compensation  
WB: White Balance  
AE: Auto Exposure  
D Zoom: Digital Zoom  
HDMI: Swap to HDMI video output  
DVI: Swap to DVI video output  
Format: Swap between different formats
7. **Power Supply Switch**  
Switch for turning camera on (i.e. Stand-By mode vs. Working mode)
8. **OSD Menu Zone**  
Dome OSD: Enter Pan Tilt Zoom OSD menu  
Lens OSD: Enter lens OSD menu
9. **Slow Zoom In/Out Zone**  
+: Zoom in slowly  
-: Zoom out slowly
10. **Focus Control Zone**  
Auto: Turn on auto focus  
Manual: Turn on manual focus  
Far: Set focus at farther distance  
Near: Set focus at nearer distance

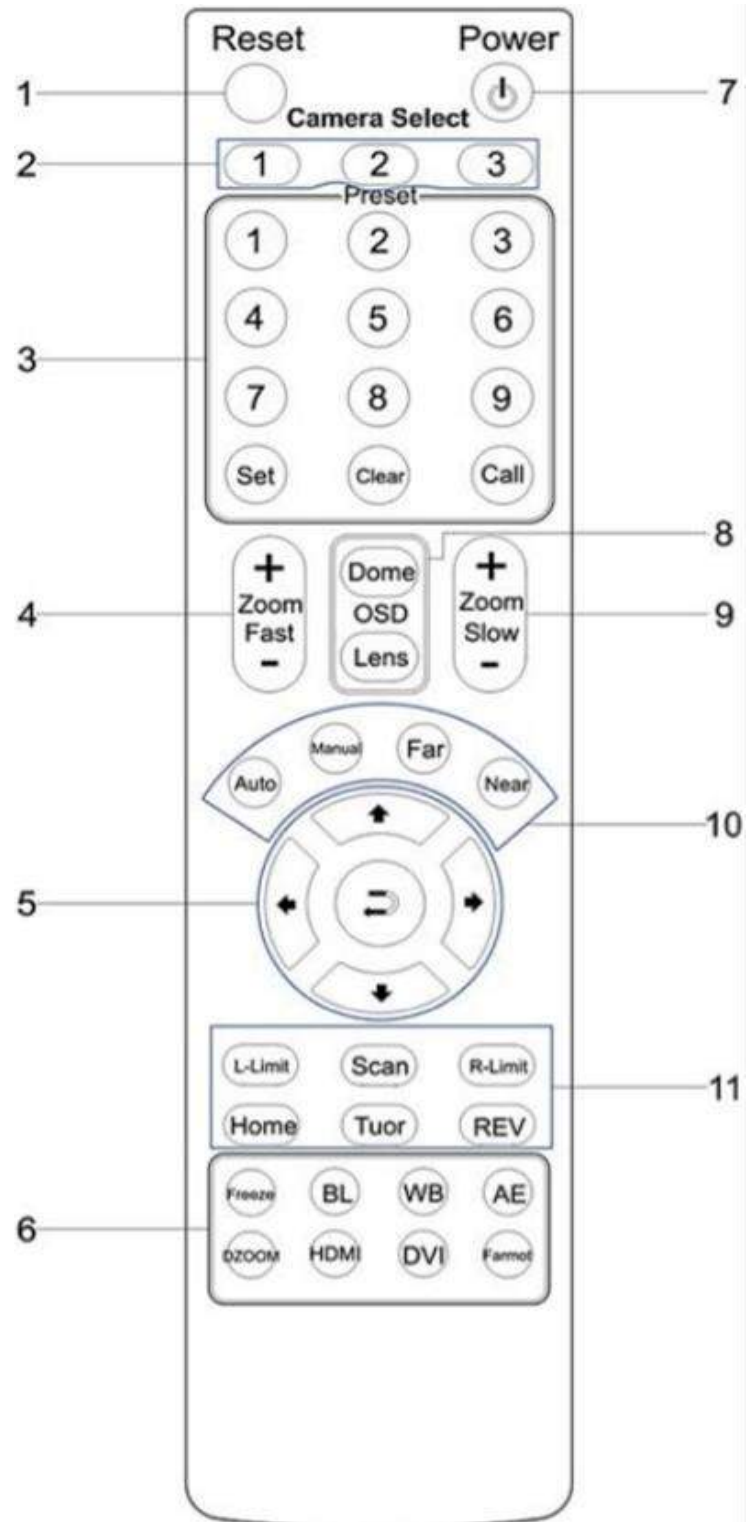



152 Robbins Rd, Downingtown, PA, 19335, USA - [HuddleCamHD.com](http://HuddleCamHD.com) | 1 800 - 486-5276

- 11. **Pan/Tilt Function Zone**
  - L-Limit: Set left boundary limit scanning position
  - Scan: Enable Boundary Scanning (Auto Panning)
  - R-Limit: Set right boundary limit scanning position
  - Home: Go to camera's Home position
  - Tour: Enable automatic patrol tour of presets
  - Rev: Enable image flip for ceiling mounting

## Connection Instructions.....

1. Connect included Power Supply to the camera.
2. Wait for camera to come to Home Position.
3. Connect included USB 3.0 cable to camera and USB 3.0 port of PC (unit is also backwards compatible with USB 2.0 port).
4. Select and configure camera in your software of choice.

**NOTE:** Failure to follow this sequence may result in no connection to PC.

## Care Of The Unit.....

Remove dust or dirt on the surface of the lens with a blower (commercially available).

## Installation Instructions.....

### Desktop Installation.....

When using the HuddleCam™ on a desk, Make sure that it will stand level. If you want to use the camera on an incline, make sure the angle is less than 15 degrees to ensure that the camera's pan and tilt mechanism operates normally.

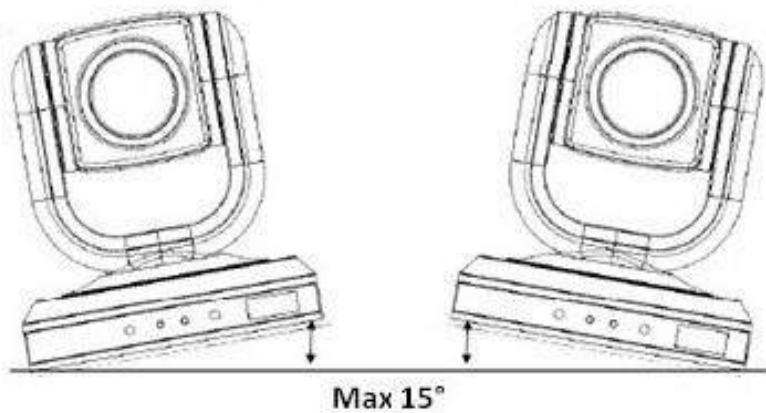

### Tripod Installation.....

When using the HuddleCam™ with a tripod, screw the tripod to the bottom of the camera. The tripod screw must fit below specifications:

Note: Tripod must stand on a level surface.

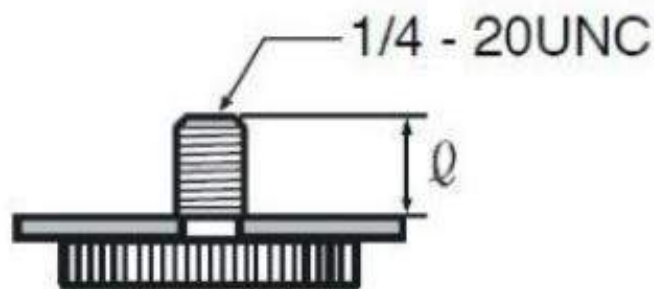

$$l = 5 - 7 \text{ mm}$$

## Ceiling Mount.....

**Step 1:**



For hard ceilings Use the supplied plastic anchors and screws to fix the ceiling bracket to the ceiling.

For acoustic tile ceilings cut a piece of plywood 12" x 23.75" to use as a tile bridge above the ceiling tile. Use the supplied screws (without plastic anchors) to fix the ceiling bracket to the plywood, sandwiching the ceiling tile in between. Do not over-tighten.

NOTE: The four raised areas of the ceiling bracket must face towards the ceiling.

---

**Step 2:**

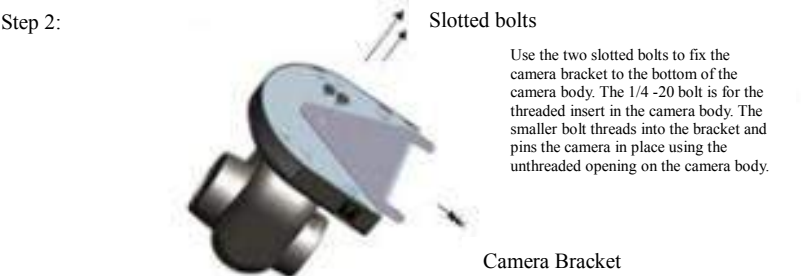

Use the two slotted bolts to fix the camera bracket to the bottom of the camera body. The 1/4 -20 bolt is for the threaded insert in the camera body. The smaller bolt threads into the bracket and pins the camera in place using the unthreaded opening on the camera body.

---

**Step 3:**

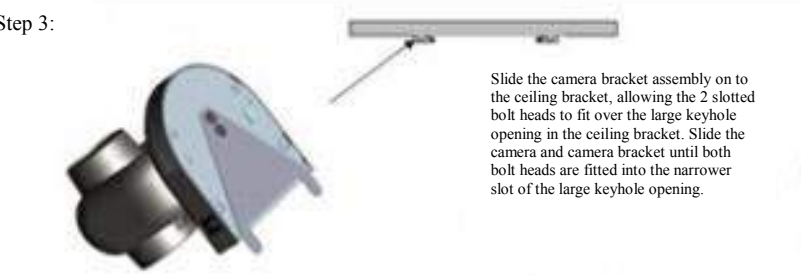

Slide the camera bracket assembly on to the ceiling bracket, allowing the 2 slotted bolt heads to fit over the large keyhole opening in the ceiling bracket. Slide the camera and camera bracket until both bolt heads are fitted into the narrower slot of the large keyhole opening.

---

**Step 4:**



Use the locking screw to lock the ceiling and camera brackets together to finish the installation



152 Robbins Rd, Downingtown, PA, 19335, USA - [HuddleCamHD.com](http://HuddleCamHD.com) | 1 800 - 486-5276

[Troubleshooting.....](#)

Problem	Cause	Resolution
There is no power to the camera.	Power adapter is disconnected from mains or from camera.	Check the connections between the camera, power adapter and mains. If anything is disconnected, reconnect it.
	Power switch is set to OFF.	Set the power switch to ON.
Camera will not connect to the PC via USB.	USB cable is bad.	Try new USB Cable
	Camera connects sometimes.	Connect USB only after camera has completely booted.
Camera unable to pan, tilt, and/or zoom.	Menu is currently displayed on the screen.	Retry after exiting the menu.
	Pan, tilt or zoom range limit was reached.	Try to pan/tilt/zoom in the other direction.
Remote control not working.	The “camera select” button on the remote control is not set to match the “IR select” switch number set on the camera.	Choose the correct “IR select” number to match camera settings.
Camera cannot be controlled via VISCA.	The connection between the PC and camera is incorrect.	Refer to Cable Connection Info section of this manual.
	Commands being sent are incorrect.	Refer to VISCA manual.
The Camera is not working at all.	No response or image from camera.	Disconnect power, and wait a few minutes, then connect the power again. Retry.



152 Robbins Rd, Downingtown, PA, 19335, USA - [HuddleCamHD.com](http://HuddleCamHD.com) | 1 800 - 486-5276

### **Important Notes Regarding USB Connectivity:**

USB 3.0 ports are backwards compatible with USB 2.0 devices. USB 2.0 ports are not completely forward compatible with USB 3.0 devices (some USB 3.0 devices will connect to USB 2.0 with limited functionality).

External USB hubs should be avoided (i.e. give the camera its own USB port on the device) as they are not well suited to transmitting HD video reliably.

USB extension systems must be fully compatible with the version of USB that you are using and must utilize an external power supply, when required. Caution: Some “compatible” USB 3.0 extenders do not actually have the full 5Gbps bandwidth required for uncompressed HD video - so check bandwidth specs. Always connect the HuddleCam directly to the device in order to associate the UVC drivers before attempting to use any extension system.

USB 3.0 power saving settings in the device’s operating system should be turned off completely for reliable USB 3.0 camera connectivity.

### **HuddleCam Cameras**

All HuddleCamHD cameras utilize the UVC (USB Video Class) drivers that are built into Windows, Mac OS and Linux to stream HD video to your device via your device’s USB port (*USB 2.0 or USB 3.0 depending upon HuddleCam model*). When your device successfully recognizes the camera, your device will register the HuddleCam as an “imaging device”. You can see this in your Windows Device Manager program (type “device manager” into the Windows search tool) as shown in the screenshot, below:





152 Robbins Rd, Downingtown, PA, 19335, USA - [HuddleCamHD.com](http://HuddleCamHD.com) | 1 800 - 486-5276

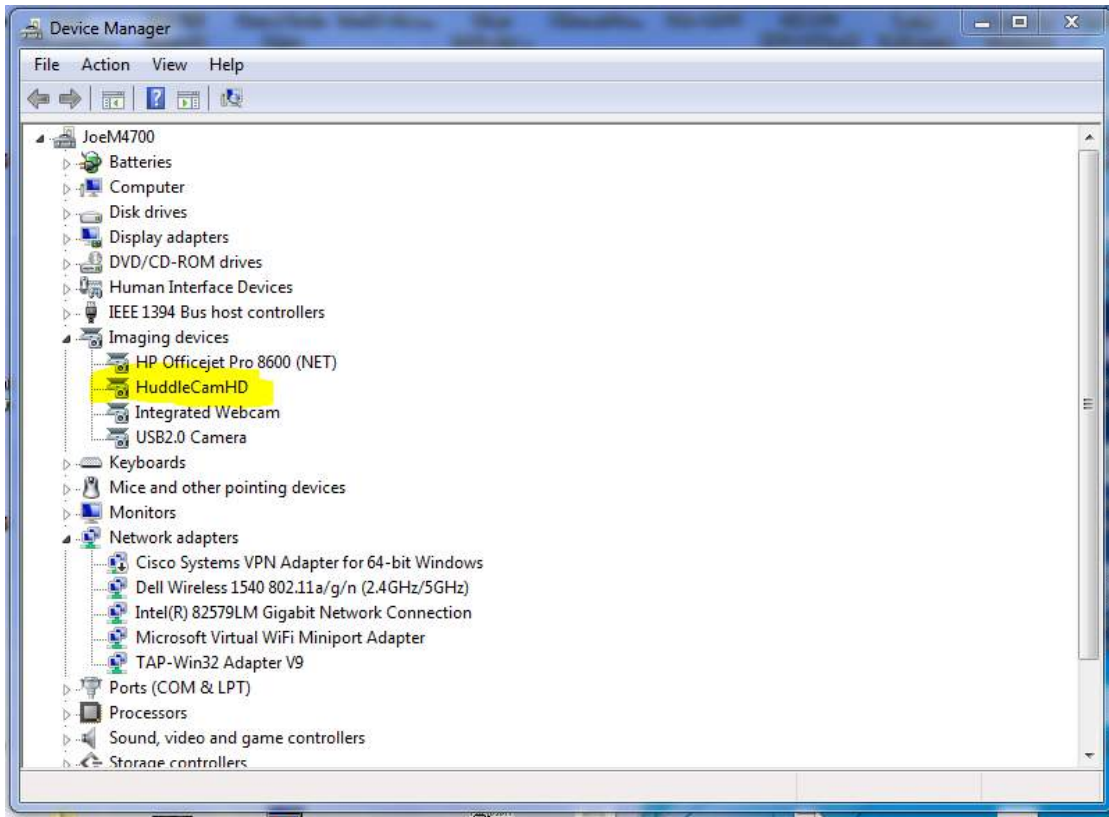

In this example, you can see the HuddleCam model in use connected as a fully functional USB 3.0 device (HuddleCamHD) as well as a USB 2.0 device with limited functionality (USB2.0 Camera).

If your device has not connected to or has not recognized the HuddleCam as an imaging device (in which case, you may see a new “unknown device”, “Westbridge” or “CYTFX3” labeled device show up in Device Manager’s “Universal Serial Bus Controllers” section rather than in the “Imaging Devices” section), the HuddleCam will not be available to programs that utilize a camera. In this case, try restarting the device and reconnecting the camera via USB (*USB 2.0 or USB 3.0 depending upon HuddleCam model*).



152 Robbins Rd, Downingtown, PA, 19335, USA - [HuddleCamHD.com](http://HuddleCamHD.com) | 1 800 - 486-5276

Similarly, you can see a connected device in System Information on a MAC. See screenshot below:



In this example, you can see the HuddleCam model in use connected as a fully functional USB 3.0 device “HuddleCamHD” as well as a “USB2.0 camera” with limited functionality (USB2.0 camera).

## Specs.....

Model Number: HC10X-xx-G3 (xx=GY Gray Color, xx=WH White Color)

### Camera & Lens

- Video CMOS Sensor 1/2.8" CMOS 2.1 Mega Pixel
- Frame Rate 30fps 1920 x 1080p, 30fps 1280 x 720p
- Lens Zoom 10X Optical Zoom, f=4.7-47mm
- Field of View 8° (tele) to 61° (wide)
- Min Lux 0.1 Lux (Color), 0.01 Lux (B/W)
- Warranty 2 years parts and labor

### Pan/Tilt Movement

- Pan Movement 0-355°
- Tilt Rotation Up: 90°, Down: 45°
- Presets IR = 9, RS232/RS485 = 64 Presets, 4 Patrol lines

### Rear Board Connectors

- Video Interface USB 3.0
- Control Signal Interface Mini DIN-8 (VISCA IN, VISCA OUT/RS485)
- Control Signal Config. Dip-Switch Pin 7/TTL Signal
- Baud Rate 9600 bps
- Power Supply Interface DC 12V 2A

### Electrical Index

- Power Supply Adapter 12V DC 2A
- Input Voltage 12V DC (10.5-14V DC)
- Input Power 24W (Max)
- Working Environment Indoor

### Physical

- Material Aluminum, Plastic
- Dimensions 5.7"W x 6.4"H x 5.8"D [7.2"H w/ Tilt Up]  
(145mm x 163mm x 148mm [183mmH w/ Tilt Up])
- Weight 2.4 lbs (1.1 kg)
- Box Dimensions 12.13" x 9.25" x 9.5" (309mm x 235mm x 242mm)
- Boxed Weight 5.6 lbs (2.55 kg)
- Color Gray or White
- Operating Temperature 32°F to +113°F (0°C to +45°C)
- Storage Temperature -14°F to 140°F (-10°C +60°C)
- Working Environment Indoor only

# Appendices.....

## Appendix 1

### VISCA Command List (1/2)

Command Set	Command	Command Packet	Comments
AddressSet	Broadcast	88 30 01 FF	Address setting
IF_Clear	Broadcast	88 01 00 01 FF	I/F Clear
CommandCancel		8x 2p FF	p: Socket No.(=1 or2)
CAM_Power	On	8x 01 04 00 02 FF	Power ON/OFF
	Off	8x 01 04 00 03 FF	
CAM_Zoom	Stop	8x 01 04 07 00 FF	Zoom Control
	Tele (Standard)	8x 01 04 07 02 FF	
	Wide (Standard)	8x 01 04 07 03 FF	
	Tele (Variable)	8x 01 04 07 2p FF	p = Speed parameter, 0 (Low) to 7 (High), 8 steps
	Wide (Variable)	8x 01 04 07 3p FF	
	Direct	8x 01 04 47 0p 0q 0r 0s FF	pqrs: Zoom Position
	D-Zoom On	8x 01 04 06 02 FF	Digital zoom: On/Off
	D-Zoom Off	8x 01 04 06 03 FF	
CAM_Focus	Stop	8x 01 04 08 00 FF	
	Far(Standard)	8x 01 04 08 02 FF	
	Near(Standard)	8x 01 04 08 03 FF	
	Far(Variable)	8x 01 04 08 2p FF	
	Near(Variable)	8x 01 04 08 3p FF	
	Direct	8x 01 04 48 0p 0q 0r 0s FF	pqrs: Focus Position
	Auto Focus	8x 01 04 38 02 FF	AF ON/OFF
	Manual Focus	8x 01 04 38 03 FF	
CAM_ZoomFocus	Direct	8x 01 04 47 0p 0q 0r 0s 0t 0u 0v 0w FF	pqrs: Zoom Position tuvw: Focus Position
CAM_WB	Auto		Normal Auto
	Indoor		Indoor mode
	Outdoor		Outdoor mode
	One Push WB		One Push WB mode
	Manual		Manual Control mode
	One Push Trigger		One Push WB Trigger
CAM_AE	Full Auto	8x 01 04 39 00 FF	Automatic Exposure mode
	Manual	8x 01 04 39 03 FF	Manual Control mode
	Shutter Priority	8x 01 04 39 0A FF	Shutter Priority Automatic Exposure mode
	Iris Priority	8x 01 04 39 0B FF	Iris Priority Automatic Exposure mode
CAM_Shutter	Direct	8x 01 04 4A 00 00 0p 0q FF	pq: Shutter Position
CAM_Iris	Direct	8x 01 04 4B 00 00 0p 0q FF	pq: Iris Position

CAM_Backlight	On	8x 01 04 33 02 FF	Back Light Compensation ON/OFF
	Off	8x 01 04 33 03 FF	
CAM_Memory	Reset	8x 01 04 3F 00 0p FF	p: Memory Number (=1 to 3F)
	Set	8x 01 04 3F 01 0p FF	Corresponds to 1 to 9 on the Remote Commander.
	Recall	8x 01 04 3F 02 0p FF	

VideoSystem SET		8x 01 06 35 00 0p FF	p	Video format	Output connetor
			1	1920×1080p/30	DVI-D HD-SDI
			2	1920×1080i/60	
			3	1280×720p/60	
			9	1920×1080p/25	

## VISCA Command List (2/2)

Command Set	Command	Command Packet	Comments		
			A	B	D
			A	1920×1080i/50	
			B	1280×720p/50	
			D	1920×1080p/24	
IR_Receive	On	8x 01 06 08 02 FF	IR(remote commander) receive ON/OFF		
	Off	8x 01 06 08 03 FF			
Color system	RGB	8x 01 7E 01 03 00 00 FF	Color-reproduction format setting for VIDEO signals		
	YPbPr	8x 01 7E 01 03 00 01 FF			
Pan-tiltDrive	Up	8x 01 06 01 VV WW 03 01 FF	VV: Pan speed 0 x01 (low speed) to 0 x18 (high speed)		
	Down	8x 01 06 01 VV WW 03 02 FF			
	Left	8x 01 06 01 VV WW 01 03 FF	WW: Tilt Speed 0 x 01 (low speed) to 0 x14 (high speed)		
	Right	8x 01 06 01 VV WW 02 03 FF			
	UpLeft	8x 01 06 01 VV WW 01 01 FF	YYYY: Pan Position 0000 to 07E0 (left 0000)		
	UpRight	8x 01 06 01 VV WW 02 01 FF			
	DownLeft	8x 01 06 01 VV WW 01 02 FF	ZZZZ: Tilt Position 0000 to 01C8 (down 0000)		
	DownRight	8x 01 06 01 VV WW 02 02 FF			
	Stop	8x 01 06 01 VV WW 03 03 FF			
	AbsolutePosition	8x 01 06 02 VV WW 0Y 0Y 0Y 0Y 0Z 0Z 0Z 0Z FF			
	RelativePosition	8x 01 06 03 VV WW 0Y 0Y 0Y 0Y 0Z 0Z 0Z 0Z FF			
	Home	8x 01 06 04 FF			
	Reset	8x 01 06 05 FF			
Pan-tiltLimitSet	LimitSet	8x 01 06 07 00 0W 0Y 0Y 0Y 0Y 0Z 0Z 0Z 0Z FF	W: 1 UpRight 0: DownLeft YYYY: Pan Position 0000 to 07E0 (left 0000)		
	LimitClear	8x 01 06 07 01 0W 07 0F 0F 0F 07 0F 0F 0F FF	ZZZZ: Tilt Position 0000 to 01C8 (down 0000)		

## Appendix 2

### VISCA Inquiry List (1/1)

Inquiry Command	Command Packet	Inquiry Packet	Comments
CAM_PowerInq	8x 09 04 00 FF	y0 50 02 FF	On
		y0 50 03 FF	Off (Standby)
		y0 50 04 FF	Internal power circuit error
CAM_ZoomPosInq	8x 09 04 47 FF	y0 50 0p 0q 0r 0s FF	pqrs: Zoom Position
CAM_FocusModeInq	8x 09 04 38 FF	y0 50 02 FF	Auto Focus
		y0 50 03 FF	Manual Focus
CAM_WBModeInq	8x 09 04 35 FF	y0 50 00 FF	Auto
		y0 50 01 FF	In Door
		y0 50 02 FF	Out Door
		y0 50 03 FF	One Push WB
		y0 50 05 FF	Manual
CAM_AEModeInq	8x 09 04 39 FF	y0 50 00 FF	Full Auto
		y0 50 03 FF	Manual
		y0 50 0A FF	Shutter Priority
		y0 50 0B FF	Iris Priority
CAM_ShutterPosInq	8x 09 04 4A FF	y0 50 00 00 0p 0q FF	pq: Shutter Position
CAM_IrisPosInq	8x 09 04 4B FF	y0 50 00 00 0p 0q FF	pq: Iris Position
CAM_BacklightModeInq	8x 09 04 33 FF	y0 50 02 FF	On
		y0 50 03 FF	Off
CAM_VersionInq	8x 09 00 02 FF	y0 50 00 01	1920×1080p/24
		mn pq rs tu vw FF	
Video SystemInq	8x 09 06 23 FF		Video format
		y0 50 01 FF	1920×1080p/30
		y0 50 02 FF	1920×1080i/60
		y0 50 03 FF	1280×720p/60
		y0 50 09 FF	1920×1080p/25
		y0 50 0A FF	1920×1080i/50
		y0 50 0B FF	1280×720p/50
		y0 50 0D FF	
Pan-tiltPosInq	8x 09 06 12 FF	y5 50 0w 0w 0w 0w	www = Pan Position
		0z 0z 0z 0z FF	zzzz = Tilt Position Speed
Color system Inq	8x 09 7E 01 03 FF	y0 50 00 FF	RGB
		y0 50 01 FF	YPbPr

### Appendix 3

#### Special Preset Commands

<b>Special Preset Call Functions:</b>	
<u>Call</u> these presets using VISCA to execute the commands	
<b>Preset No.</b>	<b>Function</b>
76	Enable Stand-by Status
77	Display Self-test (Camera Info) menu OSD
90	Flip Image Vertically (On/Off Toggle)
91	Display Dome OSD Menu
92	Set Left Pan Limit for Pan Scanning
93	Set Right Pan Limit for Pan Scanning
94	Restart Camera with Default Settings
95	Display Lens OSD Menu
96	Go to Home Position
97	Start Regional (limits) Pan Scanning
98	Start Tour Scanning (Set Tour # in Dome Menu)
99	Start Global (no limits) Pan Scanning